

SPARE PARTS KITS

INSTRUCTIONS • INSTALLATION



CAUTION



ALWAYS wear protective clothing, face shield, safety glasses and gloves when working near or performing any maintenance or replacement on your pump.

See MSDS Sheet from solution supplier for additional precautions.

READ ALL STEPS BELOW BEFORE PROCEEDING.

Depressurizing the Discharge Line (For Pumps Equipped with a 4-FV only).

1. Be sure the Injection Check Valve is properly installed and is operating. If a shut off valve has been installed downstream of the Injection Valve, it should be closed to off.



CAUTION: Be sure your relief tubing is connected to your 4-FV and runs back to your solution drum or tank.

2. Depending on the model of your 4-FV, either 1/4 turn or pull on both the yellow and black knobs on the 4-FV. The discharge line is now depressurized. Keep valve open until solution drains back down the discharge tubing into solution drum or tank. Then release or 1/4 turn knobs to normal position.

Liquifram® (Diaphragm) Replacement

When replacing the Liquifram®, the valve balls, seal rings and the injection check valve spring should also be replaced.

1. Carefully depressurize, drain, and disconnect the discharge line (See pump Instruction Manual). Place the Foot Valve into a container of water or other neutralizing solution. Turn the pump on to flush the head assembly. Once the pump head has been flushed, lift the Foot Valve out of the solution and continue to pump air into the pump head until the pump head is purged of water or neutralizing solution.

NOTE: If the liquid cannot be pumped due to Liquifram® rupture, using protective gloves, carefully disconnect the suction and discharge tubing. Remove the four screws to the head and immerse the head in water or other neutralizing solution.

2. Start the pump. While running, set the stroke knob to zero and turn the pump off (See pump Instruction Manual for proper zeroing).

3. With the unit off, unscrew the Liquifram® by carefully grasping the outer edge of the Liquifram® and turning it counter-clockwise. Discard old Liquifram®. Remove the Liquifram® disk if so equipped (located behind the Liquifram®) and check that the size code matches the size code on the replacement Liquifram® (see illustrations below).

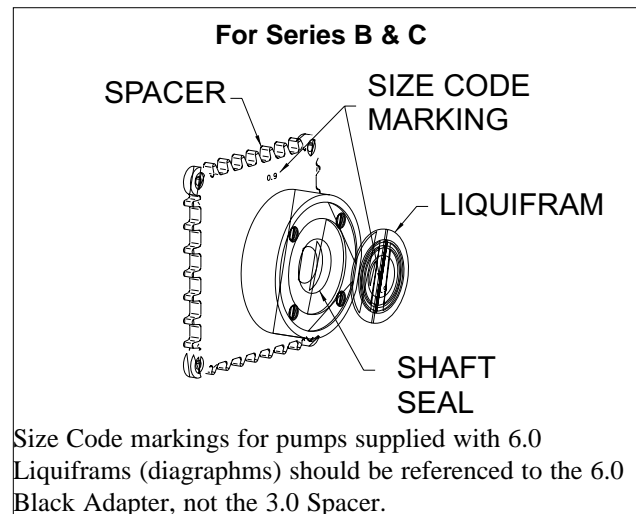
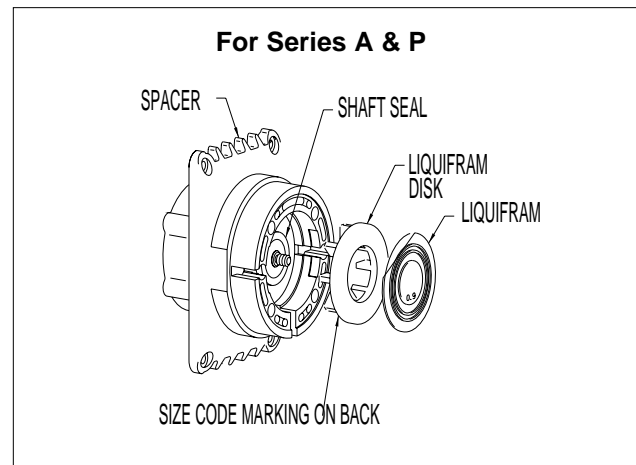

 **LMI**
MILTON ROY

8 Post Office Square
Acton, MA 01720 USA
TOLL FREE: (800) 564-1097
TEL: (508) 263-9800
FAX: (508) 264-9172
<http://www.lmipumps.com>





CAUTION : Take care not to scratch the Teflon surface of the new Liquifram®.

4. Start the pump and turn the stroke knob to the setting indicated below on Stroke Setting Chart which matches the pump model number located on the pump dataplate. With the pump stroking (running), screw on the new Liquifram® clockwise until the center begins to buckle inwards. Stop the pump.

Liquifram® Stroke Setting Chart	
Pump	Stroke Knob Setting
All A, B and P Series C10, C11, C12, C70, C71, C72, C76, C90, C91, C92 E70, E71, E72	90%
C78	50%
C13, C14, C73, C74, C77, C93, C94 E73, E74	70%
All M Series	100%. But Liquifram® must be bottomed completely. (Turned all the way) Do Not Use Straight Edge.

5. Grasp the outer edge of the Liquifram® and adjust by screwing it in or out so that the center of the Liquifram® is flush with the outside of the spacer edge (see figure 1).

6. Once the Liquifram® is properly positioned, remount the pump head to the spacer using the four (4) screws. Tighten in a criss-cross pattern. After one week of operation, recheck the screws and tighten if necessary.

Seal Ring, Ball and Injection Check Valve Spring Replacement

1. Carefully depressurize and disconnect the discharge line (See pump Instruction Manual). Place the Foot Valve into a container of water or other neutralizing solution. Turn the pump on to flush the head assembly. Once the pump has been flushed, lift the Foot Valve out and continue to pump to let air into the pump head until pump is purged of water or neutralizing solution.

If the liquid cannot be pumped due to Liquifram® rupture, with protective gloves, carefully disconnect the tubing and four screws to remove the head. Immerse the head in water or other neutralizing solution.

IMPORTANT: Before disassembling valves, note the orientation of seal ring and ball (see figure 2).

2. Carefully disconnect one tubing connection and fitting at a time and remove the worn seal ring and ball.

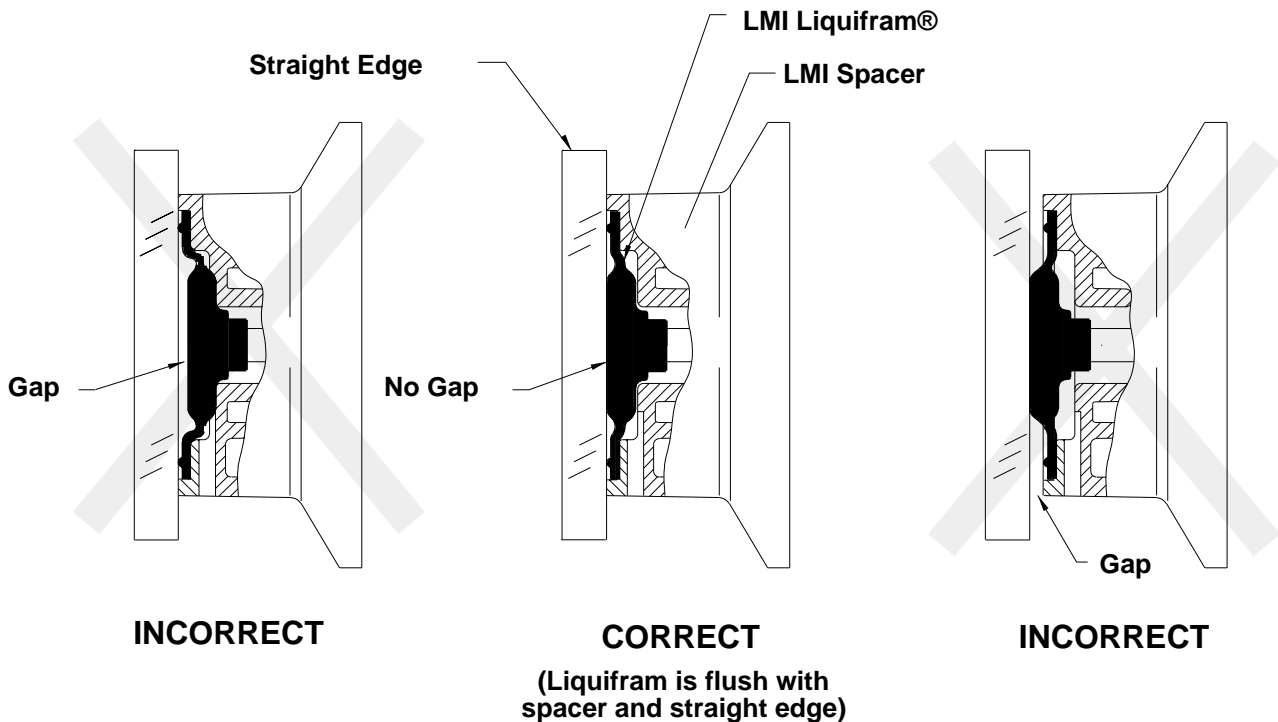

figure 1

Carefully loosen seal ring by prying side to side using a small screw driver through the center hole of the seal ring.

3. Install new seal ring and ball in each location.

IMPORTANT: Note correct orientation.

4. Install the new spring in the Injection Check Valve.

WARNING: Depressurize and drain pipeline so that Injection Check Valve can safely be disassembled.

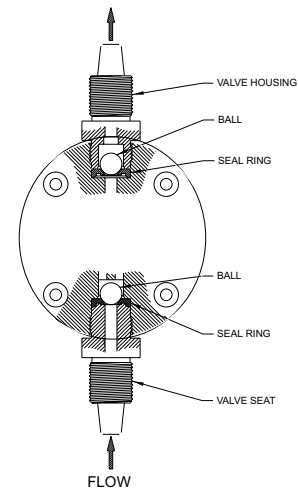
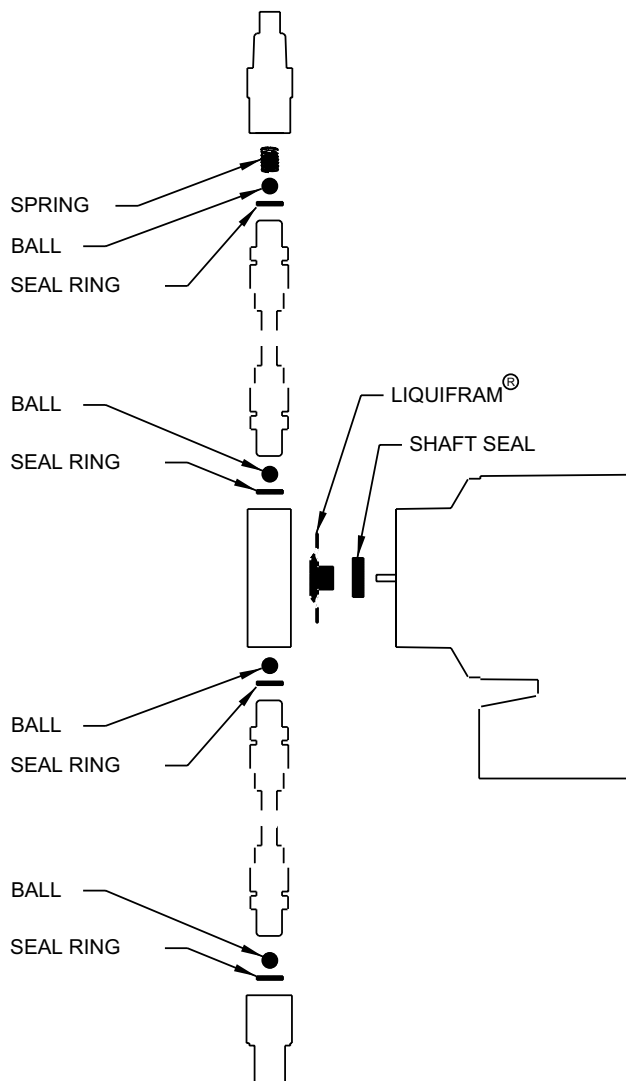

figure 2

EXPLODED VIEW & PARTS LIST GROUP 1



NOTE: Shaft seal needs to be replaced only if Liquifram® rupture has occurred or if the seal shows signs of damage.

SP KIT NUMBER	SIZE CODE	LIQUIFRAM 1 ea	SPRING 1 ea	SEAL RING 4ea	BALL 4 ea	SHAFT SEAL 1ea
SP-151FS	0.5	37341	10339	10107	10444	10973
SP-U8	0.5	37341	10339	29443	10338	10973
SP-U9	0.5	37341	10339	10407	10338	10973
SP-09	0.9	26041	37341	29443	10338	10973
SP-89	0.9	10102	10102	10107	10338	10973
SP-91H	0.9	30917	37341	10107	10338	10973
SP-92L	0.9	30917	37341	29443	10338	10973
SP-92V	0.9	30917	37341	10207	10338	10973
SP-U1	0.9	30917	37341	10407	10338	10973
SP-U3	0.9	10102	37341	10107	10444	10973
SP-U7	0.9	30917	37341	29443	10338	10973
SP-79	1.8	10105		10107	10338	10973
SP-U2	1.8	31420	37341	10407	10338	10973
SP-U4	1.8	10105	37341	10107	10444	10973
SP-U10	1.8	31420	37341	29443	10338	10973
SP-15	3.0	31419	37341	10407	10338	10973
SP-20	3.0	31419	37341	10128	10138	10973
SP-26	3.0	31419	37341	10228	10138	10973
SP-29	3.0	31419		10128	10138	10973
SP-U5	3.0	31419	37341	25128	10138	10973
SP-U17	3.0	31419	37341	29443	10338	10973
SP-U18	3.0	37341	37341	25128	10338	10973
SP-U19	6.0	37863	37341	25128	10338	10973

EXPLODED VIEW & PARTS LIST GROUP 2 - HIGH VISCOSITY LIQUID ENDS

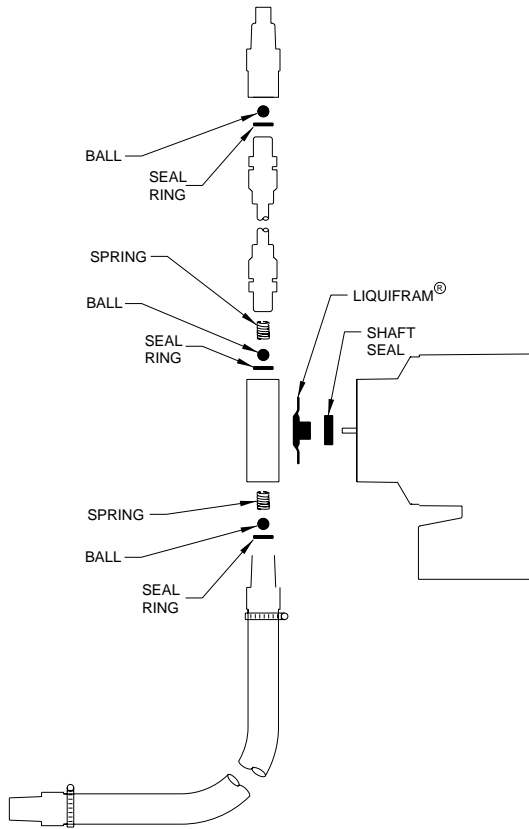

NOTE: Shaft seal needs to be replaced only if Liquifram® rupture has occurred or if the seal shows signs of damage.

SP KIT NUMBER	SIZE CODE	LIQUIFRAM 1 ea	SPRING 2 ea	SEAL RING 3 ea	BALL 3 ea	SHAFT SEAL 1 ea
SP-155FS	0.5	30916	25558	25128	25042	10973
SP-156	0.5	30916	25558	10128	25042	10973
SP-85HV	0.9	30917	25558	25128	25042	10973
SP-86	0.9	30917	25558	10128	25042	10973
SP-75HV	1.8	31420	25558	25128	25042	10973
SP-76	1.8	31420	25558	10128	25042	10973
SP-25HV	3.0	31419	25558	25128	25042	10973
SP-20HV	3.0	31419	25558	10128	25042	10973
SP-620HV	3.0	37861	25558	10128	25042	10973
SP-625HV	3.0	37861	25558	25128	25042	10973
SP-30HV	6.0	25719	25558	10128	25042	10973
SP-35HV	6.0	25719	25558	25128	25042	10973
SP-630HV	6.0	37861	25558	10128	25042	10973
SP-635HV	6.0	37861	25558	25128	25042	10973

EXPLODED VIEW & PARTS LIST GROUP 3 - STAINLESS STEEL LIQUID ENDS

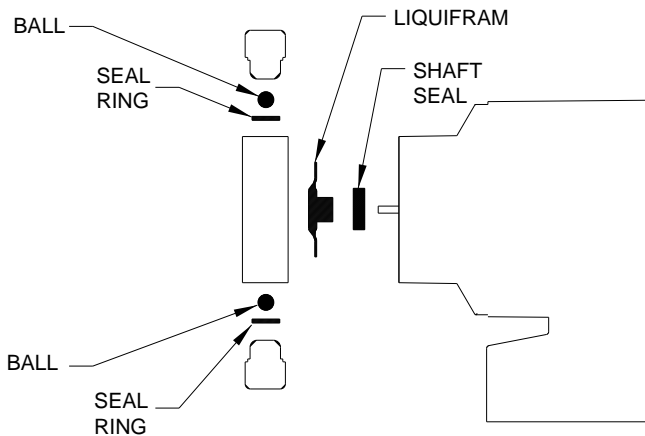

NOTE: Shaft seal needs to be replaced only if Liquifram® rupture has occurred or if the seal shows signs of damage.

SP KIT NUMBER	SIZE CODE	LIQUIFRAM 1 ea	SEAL RING 2 ea	BALL 2 ea	SHAFT SEAL 1 ea
SP-157	0.5	30916	10407	10659	10973
SP-97	0.9	30917	10407	10659	10973
SP-77	1.8	31420	10407	10659	10973
SP-27	3.0	31419	25128	25042	10973
SP-627	3.0	37861	25128	25042	10973
SP-37	6.0	25719	25128	25042	10973
SP-637	6.0	37863	25128	25042	10973



8 Post Office Square
Acton, MA 01720 USA
TOLL FREE: (800) 564-1097
TEL: (508) 263-9800
FAX: (508) 264-9172
<http://www.lmipumps.com>